

8Mb ZBT® SRAM

MT55L512L18P, MT55L512V18P,
MT55L256L32P, MT55L256V32P,
MT55L256L36P, MT55L256V36P

3.3V V_{DD}, 3.3V or 2.5V I/O

FEATURES

- High frequency and 100 percent bus utilization
- Fast cycle times: 6ns, 7.5ns and 10ns
- Single +3.3V ±5% power supply (V_{DD})
- Separate +3.3V or +2.5V isolated output buffer supply (V_{DDQ})
- Advanced control logic for minimum control signal interface
- Individual BYTE WRITE controls may be tied LOW
- Single R/W# (read/write) control pin
- CKE# pin to enable clock and suspend operations
- Three chip enables for simple depth expansion
- Clock-controlled and registered addresses, data I/Os and control signals
- Internally self-timed, fully coherent WRITE
- Internally self-timed, registered outputs to eliminate the need to control OE#
- SNOOZE MODE for reduced-power standby
- Common data inputs and data outputs
- Linear or Interleaved Burst Modes
- Burst feature (optional)
- Pin/function compatibility with 2Mb, 4Mb, and 18Mb ZBT SRAM
- Automatic power-down
- 100-pin TQFP package
- 165-pin FBGA package
- 119-pin BGA package

OPTIONS

- Timing (Access/Cycle/MHz)
 - 3.5ns/6ns/166 MHz
 - 4.2ns/7.5ns/133 MHz
 - 5ns/10ns/100 MHz
- Configurations
 - 3.3V I/O
 - 512K x 18
 - 256K x 32
 - 256K x 36
 - 2.5V I/O
 - 512K x 18
 - 256K x 32
 - 256K x 36
- Package
 - 100-pin TQFP
 - 165-pin, 13mm x 15mm FBGA
 - 119-pin, 14mm x 22mm BGA
- Operating Temperature Range
 - Commercial (0°C to +70°C)
 - Industrial (-40°C to +85°C)**

MARKING*

	-6	
	-7.5	
	-10	
		MT55L512L18P
		MT55L256L32P
		MT55L256L36P
		MT55L512V18P
		MT55L256V32P
		MT55L256V36P

T
F
B

None
IT

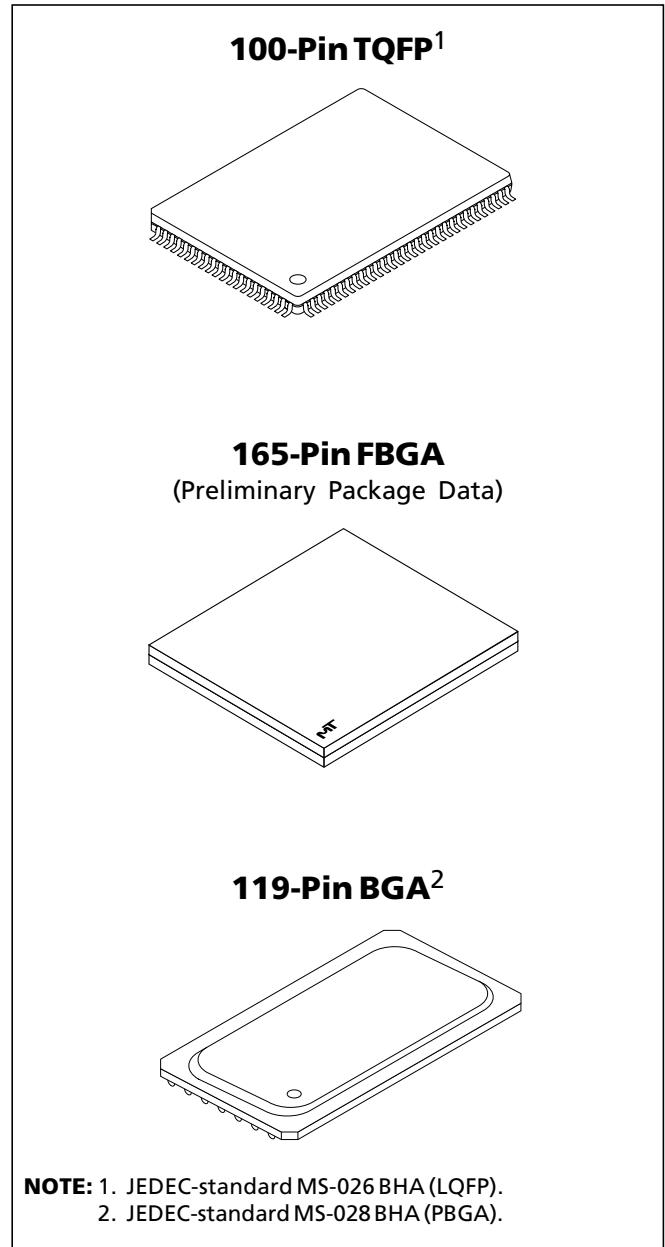

100-Pin TQFP¹

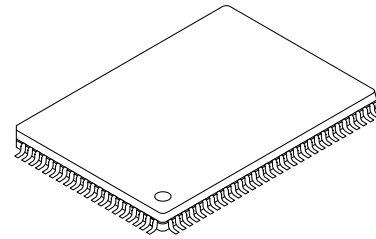

165-Pin FBGA
(Preliminary Package Data)

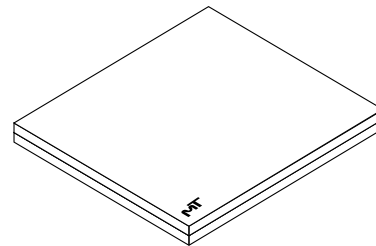

119-Pin BGA²

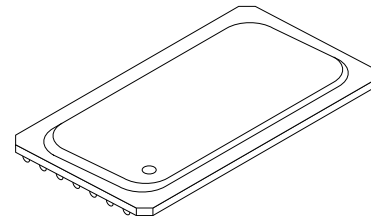

NOTE: 1. JEDEC-standard MS-026 BHA (LQFP).
2. JEDEC-standard MS-028 BHA (PBGA).

Part Number Example:
MT55L256L32P-7.5

* A Part Marking Guide for the FBGA devices can be found on Micron's web site—<http://www.micron.com/support/index.html>.

** Industrial temperature range offered in specific speed grades and configurations. Contact factory for more information.

**FUNCTIONAL BLOCK DIAGRAM
512K x 18**

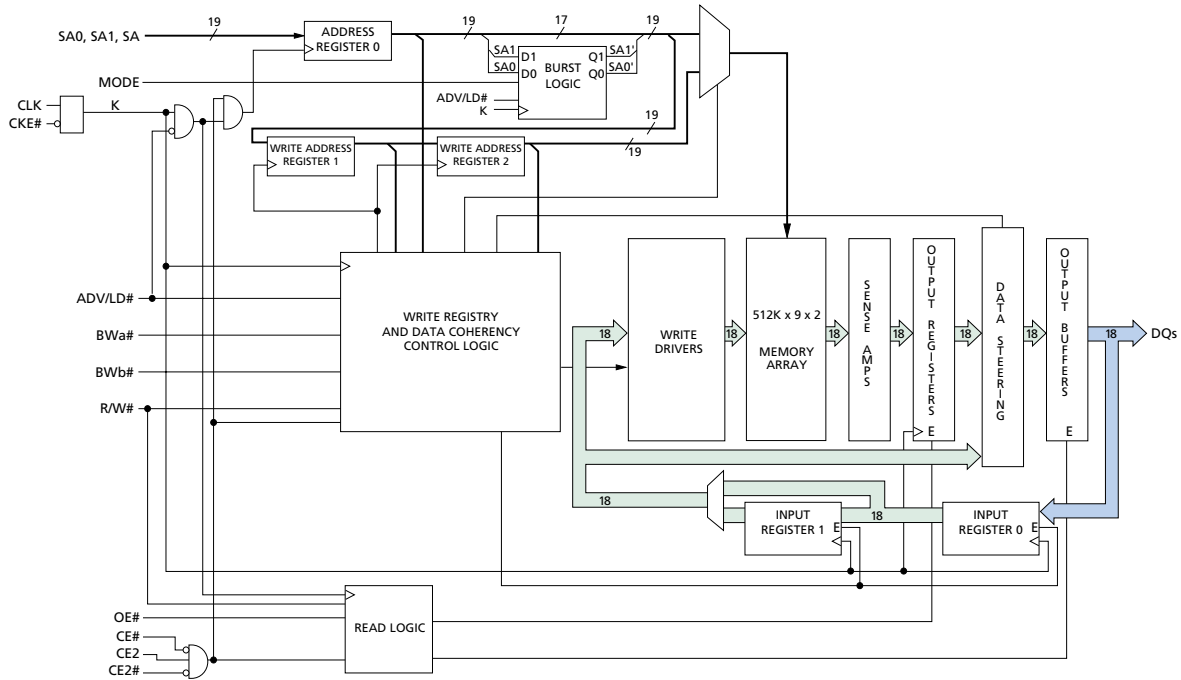

**FUNCTIONAL BLOCK DIAGRAM
256K x 32/36**

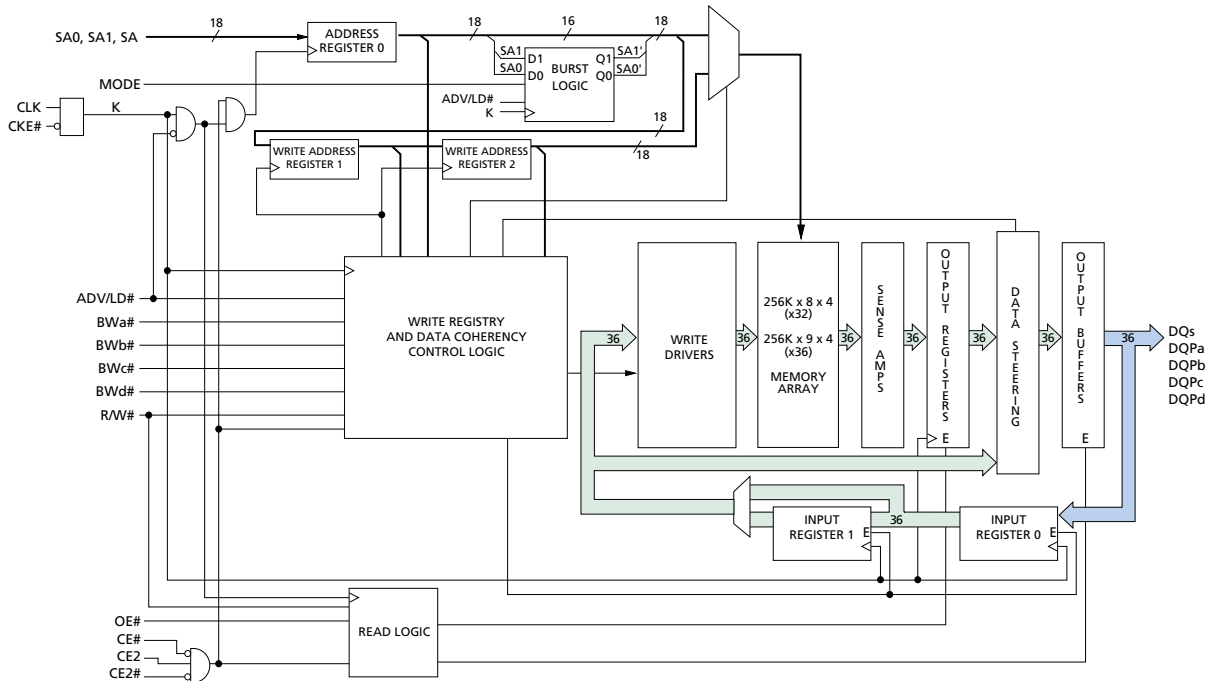

NOTE: Functional block diagrams illustrate simplified device operation. See truth table, pin descriptions, and timing diagrams for detailed information.

GENERAL DESCRIPTION

The Micron[®] Zero Bus Turnaround[™] (ZBT[®]) SRAM family employs high-speed, low-power CMOS designs using an advanced CMOS process.

Micron's 8Mb ZBT SRAMs integrate a 512K x 18, 256K x 32, or 256K x 36 SRAM core with advanced synchronous peripheral circuitry and a 2-bit burst counter. These SRAMs are optimized for 100 percent bus utilization, eliminating any turnaround cycles for READ to WRITE, or WRITE to READ, transitions. All synchronous inputs pass through registers controlled by a positive-edge-triggered single clock input (CLK). The synchronous inputs include all addresses, all data inputs, chip enable (CE#), two additional chip enables for easy depth expansion (CE2, CE2#), cycle start input (ADV/LD#), synchronous clock enable (CKE#), byte write enables (BWA#, BWb#, BWc#, and BWD#), and read/write (R/W#).

Asynchronous inputs include the output enable (OE#, which may be tied LOW for control signal minimization), clock (CLK), and snooze enable (ZZ, which may be tied LOW if unused). There is also a burst mode pin (MODE) that selects between interleaved and linear burst modes. MODE may be tied HIGH, LOW, or left unconnected if burst is unused. The data-out (Q), enabled by OE#, is registered by the rising edge of CLK. WRITE cycles can be from one to four bytes wide as controlled by the write control inputs.

All READ, WRITE, and DESELECT cycles are initiated by the ADV/LD# input. Subsequent burst

addresses can be internally generated as controlled by the burst advance pin (ADV/LD#). Use of burst mode is optional. It is allowable to give an address for each individual READ and WRITE cycle. BURST cycles wrap around after the fourth access from a base address.

To allow for continuous, 100 percent use of the data bus, the pipelined ZBT SRAM uses a LATE LATE WRITE cycle. For example, if a WRITE cycle begins in clock cycle one, the address is present on rising edge one. BYTE WRITES need to be asserted on the same cycle as the address. The data associated with the address is required two cycles later, or on the rising edge of clock cycle three.

Address and write control are registered on-chip to simplify WRITE cycles. This allows self-timed WRITE cycles. Individual byte enables allow individual bytes to be written. During a BYTE WRITE cycle, BWA# controls DQa pins; BWb# controls DQb pins; BWc# controls DQc pins; and BWD# controls DQd pins. Cycle types can only be defined when an address is loaded, i.e., when ADV/LD# is LOW. Parity/ECC bits are only available on the x36 version.

Micron's 8Mb ZBT SRAMs operate from a +3.3V V_{DD} power supply, and all inputs and outputs are LVTTTL-compatible. Users can choose either a 2.5V or 3.3V I/O version. The device is ideally suited for systems requiring high bandwidth and zero bus turnaround delays.

Please refer to Micron's Web site (www.micron.com/datasheets) for the latest data sheet.

TQFP PIN ASSIGNMENT TABLE

PIN #	x18	x32	x36
1	NC	NF	DQPc
2	NC	DQc	DQc
3	NC	DQc	DQc
4	V _{DDQ}		
5	V _{SS}		
6	NC	DQc	DQc
7	NC	DQc	DQc
8	DQb	DQc	DQc
9	DQb	DQc	DQc
10	V _{SS}		
11	V _{DDQ}		
12	DQb	DQc	DQc
13	DQb	DQc	DQc
14	V _{DD}		
15	V _{DD}		
16	V _{DD1}		
17	V _{SS}		
18	DQb	DQd	DQd
19	DQb	DQd	DQd
20	V _{DDQ}		
21	V _{SS}		
22	DQb	DQd	DQd
23	DQb	DQd	DQd
24	DQb	DQd	DQd
25	NC	DQd	DQd

PIN #	x18	x32	x36
26	V _{SS}		
27	V _{DDQ}		
28	NC	DQd	DQd
29	NC	DQd	DQd
30	NC	NF	DQPd
31	MODE (LBO#)		
32	SA		
33	SA		
34	SA		
35	SA		
36	SA1		
37	SA0		
38	DNU		
39	DNU		
40	V _{SS}		
41	V _{DD}		
42	DNU		
43	DNU		
44	SA		
45	SA		
46	SA		
47	SA		
48	SA		
49	SA		
50	SA		

PIN #	x18	x32	x36
51	NC	NF	DQP _a
52	NC	DQ _a	DQ _a
53	NC	DQ _a	DQ _a
54	V _{DDQ}		
55	V _{SS}		
56	NC	DQ _a	DQ _a
57	NC	DQ _a	DQ _a
58	DQ _a		
59	DQ _a		
60	V _{SS}		
61	V _{DDQ}		
62	DQ _a		
63	DQ _a		
64	ZZ		
65	V _{DD}		
66	V _{DD1}		
67	V _{SS}		
68	DQ _a	DQ _b	DQ _b
69	DQ _a	DQ _b	DQ _b
70	V _{DDQ}		
71	V _{SS}		
72	DQ _a	DQ _b	DQ _b
73	DQ _a	DQ _b	DQ _b
74	DQ _a	DQ _b	DQ _b
75	NC	DQ _b	DQ _b

PIN #	x18	x32	x36
76	V _{SS}		
77	V _{DDQ}		
78	NC	DQ _b	DQ _b
79	NC	DQ _b	DQ _b
80	SA	NF	DQP _b
81	SA		
82	SA		
83	SA		
84	NF ₂		
85	ADV/LD#		
86	OE# (G#)		
87	CKE#		
88	RW#		
89	CLK		
90	V _{SS}		
91	V _{DD}		
92	CE ₂ #		
93	BW _a #		
94	BW _b #		
95	NC	BW _c #	BW _c #
96	NC	BW _d #	BW _d #
97	CE ₂		
98	CE#		
99	SA		
100	SA		

- NOTE:**
1. Pins 16 and 66 do not have to be connected directly to V_{DD} if the input voltage is ≥ V_{IH}.
 2. Pin 84 is reserved for expansion to 18Mb device.

**PIN ASSIGNMENT (TOP VIEW)
100-PIN TQFP**

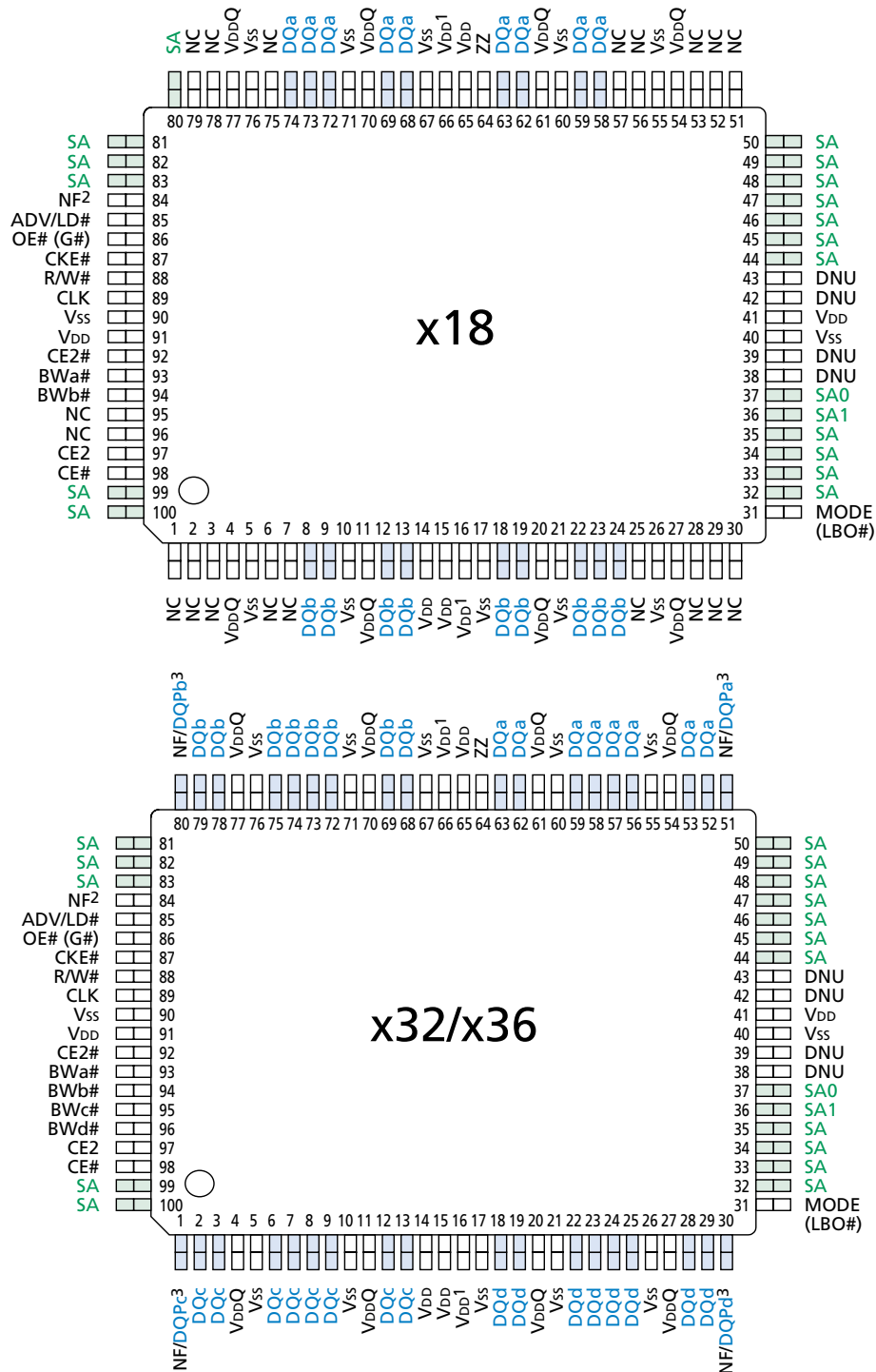

- NOTE:**
1. Pins 16 and 66 do not have to be connected directly to V_{DD} if the input voltage is $\geq V_{IH}$.
 2. Pin 84 is reserved for expansion to 18Mb device.
 3. NF for x32 version, DQP_x for x36 version.

TQFP PIN DESCRIPTIONS

x18	x32/x36	SYMBOL	TYPE	DESCRIPTION
37 36 32-35, 44-50, 80-83, 99, 100	37 36 32-35, 44-50, 81-83, 99, 100	SA0 SA1 SA	Input	Synchronous Address Inputs: These inputs are registered and must meet the setup and hold times around the rising edge of CLK. Pin 84 is reserved as an address bit for higher-density 18Mb ZBT SRAMs. SA0 and SA1 are the two least significant bits (LSB) of the address field and set the internal burst counter if burst is desired.
93 94 – –	93 94 95 96	BWa# BWb# BWc# BWD#	Input	Synchronous Byte Write Enables: These active LOW inputs allow individual bytes to be written when a WRITE cycle is active and must meet the setup and hold times around the rising edge of CLK. BYTE WRITES need to be asserted on the same cycle as the address. BWs are associated with addresses and apply to subsequent data. BWa# controls DQa pins; BWb# controls DQb pins; BWc# controls DQc pins; BWD# controls DQd pins.
89	89	CLK	Input	Clock: This signal registers the address, data, chip enables, byte write enables, and burst control inputs on its rising edge. All synchronous inputs must meet setup and hold times around the clock's rising edge.
98	98	CE#	Input	Synchronous Chip Enable: This active LOW input is used to enable the device and is sampled only when a new external address is loaded (ADV/LD# is LOW).
92	92	CE2#	Input	Synchronous Chip Enable: This active LOW input is used to enable the device and is sampled only when a new external address is loaded (ADV/LD# is LOW). This input can be used for memory depth expansion.
97	97	CE2	Input	Synchronous Chip Enable: This active HIGH input is used to enable the device and is sampled only when a new external address is loaded (ADV/LD# is LOW). This input can be used for memory depth expansion.
86	86	OE# (G#)	Input	Output Enable: This active LOW, asynchronous input enables the data I/O output drivers. G# is the JEDEC-standard term for OE#.
85	85	ADV/LD#	Input	Synchronous Address Advance/Load: When HIGH, this input is used to advance the internal burst counter, controlling burst access after the external address is loaded. When ADV/LD# is HIGH, R/W# is ignored. A LOW on ADV/LD# clocks a new address at the CLK rising edge.
87	87	CKE#	Input	Synchronous Clock Enable: This active LOW input permits CLK to propagate throughout the device. When CKE# is HIGH, the device ignores the CLK input and effectively internally extends the previous CLK cycle. This input must meet setup and hold times around the rising edge of CLK.
64	64	ZZ	Input	Snooze Enable: This active HIGH, asynchronous input causes the device to enter a low-power standby mode in which all data in the memory array is retained. When ZZ is active, all other inputs are ignored.

(continued on next page)

TQFP PIN DESCRIPTIONS (CONTINUED)

x18	x32/x36	SYMBOL	TYPE	DESCRIPTION
88	88	R/W#	Input	Read/Write: This input determines the cycle type when ADV/LD# is LOW and is the only means for determining READs and WRITEs. READ cycles may not be converted into WRITEs (and vice versa) other than by loading a new address. A LOW on this pin permits BYTE WRITE operations and must meet the setup and hold times around the rising edge of CLK. Full bus-width WRITEs occur if all byte write enables are LOW.
31	31	MODE (LBO#)	Input	Mode: This input selects the burst sequence. A LOW on this pin selects linear burst. NC or HIGH on this pin selects interleaved burst. Do not alter input state while device is operating. LBO# is the JEDEC-standard term for MODE.
(a) 58, 59, 62, 63, 68, 69, 72-74 (b) 8, 9, 12, 13, 18, 19, 22-24	(a) 52, 53, 56-59, 62, 63 (b) 68, 69, 72-75, 78, 79 (c) 2, 3, 6-9, 12, 13 (d) 18, 19, 22-25, 28, 29	DQa DQb DQc DQd	Input/ Output	SRAM Data I/Os: Byte "a" is associated with DQa pins; Byte "b" is associated with DQb pins; Byte "c" is associated with DQc pins; Byte "d" is associated with DQd pins. Input data must meet setup and hold times around the rising edge of CLK.
n/a	51 80 1 30	NF/DQPa NF/DQPb NF/DQPC NF/DQPD	NF/ I/O	No Function/Data Bits: On the x32 version, these pins are No Function (NF) and can be left floating or connected to GND to minimize thermal impedance. On the x36 version, these bits are DQPs.
14, 15, 16, 41, 65, 66, 91	14, 15, 16, 41, 65, 66, 91	V _{DD}	Supply	Power Supply: See DC Electrical Characteristics and Operating Conditions for range.
4, 11, 20, 27, 54, 61, 70, 77	4, 11, 20, 27, 54, 61, 70, 77	V _{DDQ}	Supply	Isolated Output Buffer Supply: See DC Electrical Characteristics and Operating Conditions for range.
5, 10, 17, 21, 26, 40, 55, 60, 67, 71, 76, 90	5, 10, 17, 21, 26, 40, 55, 60, 67, 71, 76, 90	V _{SS}	Supply	Ground: GND.
1-3, 6, 7, 25, 28-30, 51-53, 56, 57, 75, 78, 79, 95, 96	n/a	NC	–	No Connect: These pins can be left floating or connected to GND to minimize thermal impedance.
38, 39, 42, 43	38, 39, 42, 43	DNU	–	Do Not Use: These signals may either be unconnected or wired to GND to minimize thermal impedance.
84	84	NF	–	No Function: This pin is internally connected to the die and will have the capacitance of an input pin. It is allowable to leave this pin unconnected or driven by signals. Pin 84 is reserved as an address pin for the 18Mb ZBT SRAM.

**PIN LAYOUT (TOP VIEW)
165-PIN FBGA**

X18

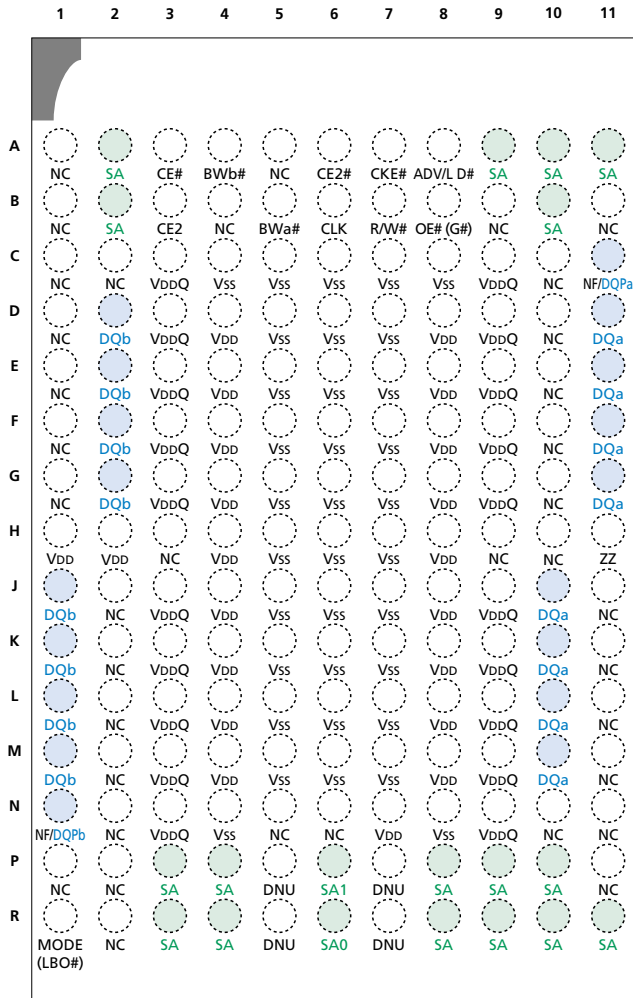

TOP VIEW

X32/X36

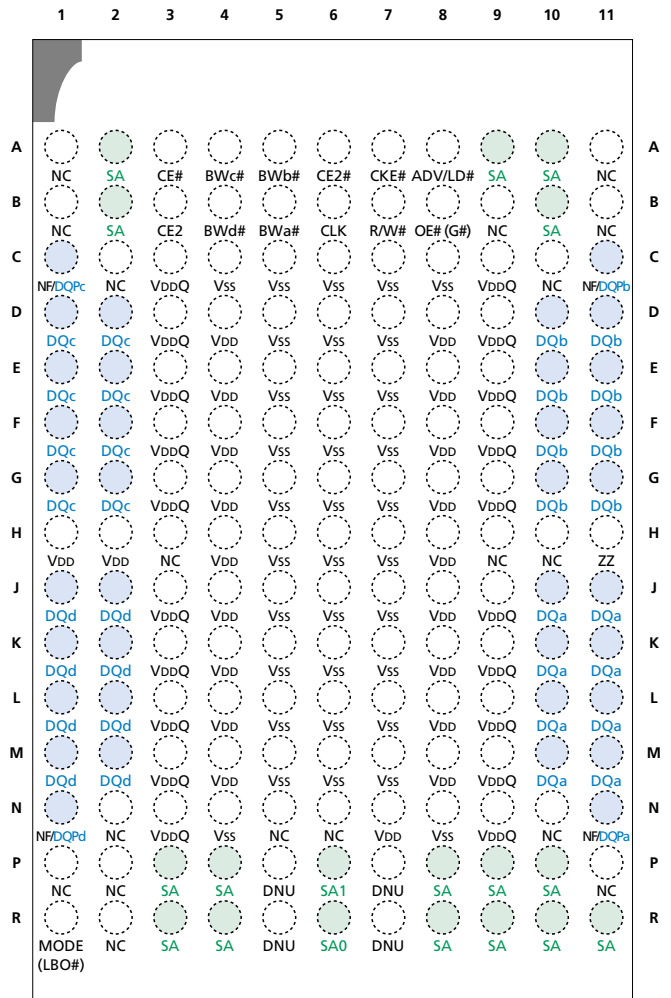

TOP VIEW

*No Function (NF) is used on the x32 version. Parity (DQPx) is used on the x36 version.

NOTE: Pin 9B reserved for address pin expansion; 18Mb.

FBGA PIN DESCRIPTIONS

x18	x32/x36	SYMBOL	TYPE	DESCRIPTION
6R 6P 2A, 9A, 10A, 11A, 2B, 10B, 3P, 4P, 8P, 9P, 10P, 3R, 4R, 8R, 9R, 10R, 11R	6R 6P 2A, 9A, 10A, 2B, 10B, 3P, 4P, 8P, 9P, 10P, 3R, 4R, 8R, 9R, 10R, 11R	SA0 SA1 SA	Input	Synchronous Address Inputs: These inputs are registered and must meet the setup and hold times around the rising edge of CLK.
5B 4A – –	5B 5A 4A 4B	BWa# BWb# BWc# Bwd#	Input	Synchronous Byte Write Enables: These active LOW inputs allow individual bytes to be written and must meet the setup and hold times around the rising edge of CLK. A byte write enable is LOW for a WRITE cycle and HIGH for a READ cycle. For the x18 version, BWa# controls DQa's and DQP _a ; BWb# controls DQb's and DQP _b . For the x32 and x36 versions, BWa# controls DQa's and DQP _a ; BWb# controls DQb's and DQP _b ; BWc# controls DQc's and DQP _c ; Bwd# controls DQd's and DQP _d . Parity is only available on the x18 and x36 versions.
7A	7A	CKE#	Input	Synchronous Clock Enable: This active LOW input permits CLK to propagate throughout the device. When CKE# is HIGH, the device ignores the CLK input and effectively internally extends the previous CLK cycle. This input must meet the setup and hold times around the rising edge of CLK.
7B	7B	R/W#	Input	Read/Write: This input determines the cycle type when ADV/LD# is LOW and is the only means for determining READs and WRITEs. READ cycles may not be converted into WRITEs (and vice versa) other than by loading a new address. A LOW on this pin permits BYTE WRITE operations to meet the setup and hold times around the rising edge of CLK. Full bus-width WRITEs occur if all byte write enables are LOW.
6B	6B	CLK	Input	Clock: This signal registers the address, data, chip enable, byte write enables and burst control inputs on its rising edge. All synchronous inputs must meet setup and hold times around the clock's rising edge.
3A	3A	CE#	Input	Synchronous Chip Enable: This active LOW input is used to enable the device. CE# is sampled only when a new external address is loaded.
6A	6A	CE2#	Input	Synchronous Chip Enable: This active LOW input is used to enable the device and is sampled only when a new external address is loaded.
11H	11H	ZZ	Input	Snooze Enable: This active HIGH, asynchronous input causes the device to enter a low-power standby mode in which all data in the memory array is retained. When ZZ is active, all other inputs are ignored.
3B	3B	CE2	Input	Synchronous Chip Enable: This active HIGH input is used to enable the device and is sampled only when a new external address is loaded.

(continued on next page)

FBGA PIN DESCRIPTIONS (CONTINUED)

x18	x32/x36	SYMBOL	TYPE	DESCRIPTION
8B	8B	OE# (G#)	Input	Output Enable: This active LOW, asynchronous input enables the data I/O output drivers.
8A	8A	ADV/LD#	Input	Synchronous Address Advance/Load: When HIGH, this input is used to advance the internal burst counter, controlling burst access after the external address is loaded. When ADV/LD# is HIGH, R/W# is ignored. A LOW on ADV/LD# clocks a new address at the CLK rising edge.
1R	1R	MODE (LBO#)	Input	Mode: This input selects the burst sequence. A LOW on this input selects "linear burst." NC or HIGH on this input selects "interleaved burst." Do not alter input state while device is operating.
(a) 10J, 10K, 10L, 10M, 11D 11E, 11F, 11G (b) 2D, 2E, 2F, 2G, 1J, 1K, 1L, 1M	(a) 10J, 10K, 10L, 10M, 11J, 11K, 11L, 11M (b) 10D, 10E, 10F, 10G, 11D, 11E, 11F, 11G (c) 1D, 1E, 1F, 1G, 2D, 2E, 2F, 2G, (d) 1J, 1K, 1L, 1M, 2J, 2K, 2L, 2M	DQa DQb DQc DQd	Input/ Output	SRAM Data I/Os: For the x18 version, Byte "a" is associated with DQa's; Byte "b" is associated with DQb's. For the x32 and x36 versions, Byte "a" is associated with DQa's; Byte "b" is associated with DQb's; Byte "c" is associated with DQc's; Byte "d" is associated with DQd's. Input data must meet setup and hold times around the rising edge of CLK.
11C 1N – –	11N 11C 1C 1N	NF/DQPa NF/DQPb NF/DQPc NF/DQPd	NF/ I/O	No Function/Parity Data I/Os: On the x32 version, these are No Function(NF). On the x18 version, Byte "a" parity is DQPa; Byte "b" parity is DQPb. On the x36 version, Byte "a" parity is DQPa; Byte "b" parity is DQPb; Byte "c" parity is DQPc; Byte "d" parity is DQPd.
1H, 2H, 4D, 4E, 4F, 4G, 4H, 4J, 4K, 4L, 4M, 7N, 8D, 8E, 8F, 8G,8H, 8J, 8K, 8L, 8M	1H, 2H, 4D, 4E, 4F, 4G, 4H, 4J, 4K, 4L, 4M, 7N, 8D, 8E, 8F, 8G,8H, 8J, 8K, 8L, 8M	V _{DD}	Supply	Power Supply: See DC Electrical Characteristics and Operating Conditions for range.
3C, 3D, 3E, 3F, 3G, 3J, 3K, 3L, 3M, 3N, 9C, 9D, 9E, 9F, 9G, 9J, 9K, 9L, 9M, 9N	3C, 3D, 3E, 3F, 3G, 3J, 3K, 3L, 3M, 3N, 9C, 9D, 9E, 9F, 9G, 9J, 9K, 9L, 9M, 9N	V _{DDQ}	Supply	Isolated Output Buffer Supply: See DC Electrical Characteristics and Operating Conditions for range.

(continued on next page)

FBGA PIN DESCRIPTIONS (CONTINUED)

x18	x32/x36	SYMBOL	TYPE	DESCRIPTION
4C, 4N, 5C, 5D, 5E, 5F, 5G, 5H, 5J, 5K, 5L, 5M, 6C, 6D, 6E, 6F, 6G, 6H, 6J, 6K, 6L, 6M, 7C, 7D, 7E, 7F, 7G, 7H, 7J, 7K, 7L, 7M, 8C, 8N	4C, 4N, 5C, 5D, 5E, 5F, 5G, 5H, 5J, 5K, 5L, 5M, 6C, 6D, 6E, 6F, 6G, 6H, 6J, 6K, 6L, 6M, 7C, 7D, 7E, 7F, 7G, 7H, 7J, 7K, 7L, 7M, 8C, 8N	V _{SS}	Supply	Ground: GND.
5P, 7P, 5R, 7R	5P, 7P, 5R, 7R	DNU	—	Do Not Use: These signals may either be unconnected or wired to GND to improve package heat dissipation.
1A, 1B, 1C, 1D, 1E, 1F, 1G, 1P, 2C, 2J, 2K, 2L, 2M, 2N, 2P, 2R, 3H, 4B, 5A, 5N, 6N, 9B, 9H, 10C, 10D, 10E, 10F, 10G, 10H, 10N, 11B, 11J, 11K, 11L, 11M, 11N, 11P	1A, 1B, 1P, 2C, 2N, 2P, 2R, 3H, 5N, 6N, 9B, 9H, 10C, 10H, 10N, 11A, 11B, 11P	NC	—	No Connect: These signals are not internally connected and may be connected to ground to improve package heat dissipation. Pin 9B is reserved for address pin expansion; 16MB.
		NF	—	No Function: These pins are internally connected to the die and have the capacitance of an input pin. It is allowable to leave these pins unconnected or driven by signals.

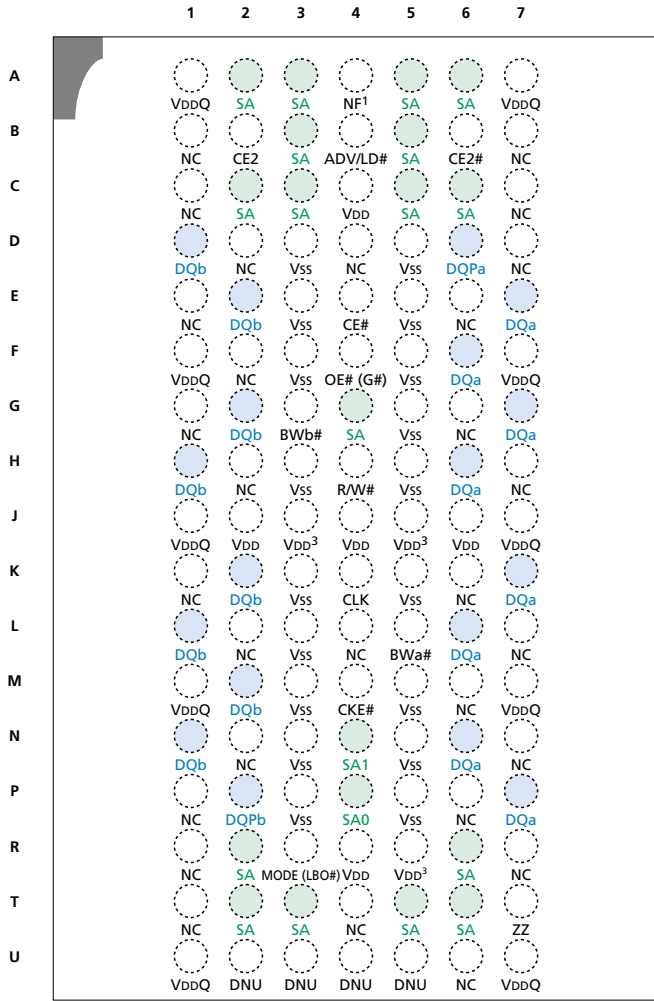
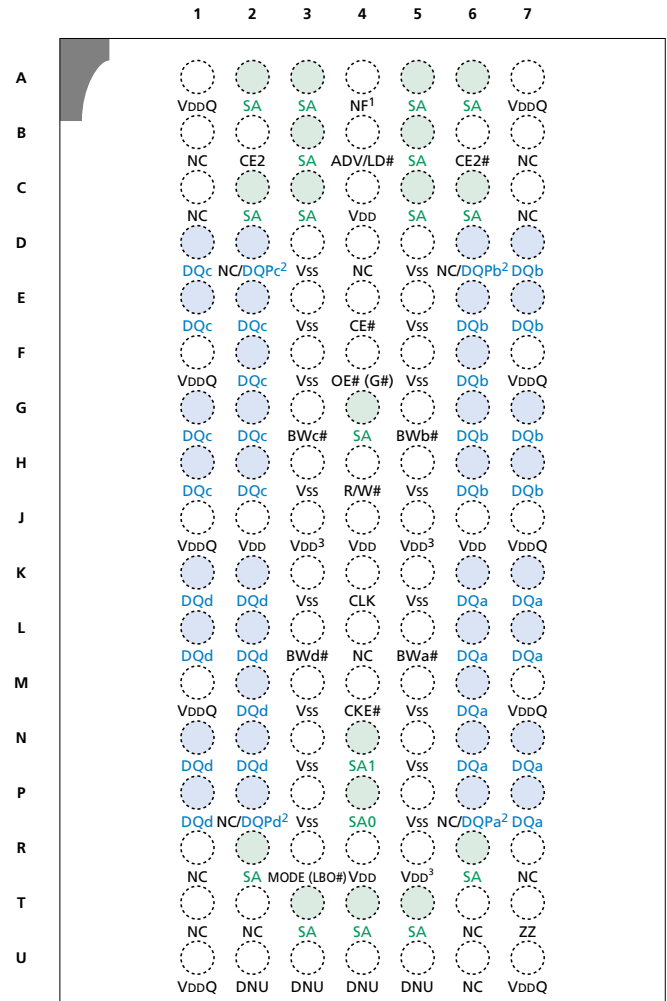
**PIN LAYOUT (TOP VIEW)
119-PIN BGA**
x18

TOP VIEW
x32/x36

TOP VIEW

- NOTE:**
- Pin 4A is reserved for address expansion to 18Mb.
 - No Function (NF) is used on the x32 version. Parity (DQP_x) is used on the x36 version.
 - Pin 3J, 5J, and 5R do not have to be connected directly to V_{DD} if the input voltage is ≥ V_{IH}.

BGA PIN DESCRIPTIONS

x18	x32/x36	SYMBOL	TYPE	DESCRIPTION
4P 4N 2A, 3A, 5A, 6A, 3B, 5B, 2C, 3C, 5C, 6C, 2R, 6R, 2T, 3T, 5T, 6T	4P 4N 2A, 2C, 2R, 3A, 3B, 3C, 3T, 4T, 5A, 5B, 5C, 5T, 6A, 6C, 6R	SA0 SA1 SA	Input	Synchronous Address Inputs: These inputs are registered and must meet the setup and hold times around the rising edge of CLK.
5L 3G – –	5L 5G 3G 3L	BWa# BWb# BWc# BWD#	Input	Synchronous Byte Write Enables: These active LOW inputs allow individual bytes to be written and must meet the setup and hold times around the rising edge of CLK. A byte write enable is LOW for a WRITE cycle and HIGH for a READ cycle. For the x18 version, BWa# controls DQa's and DQPa; BWb# controls DQb's and DQPb. For the x32 and x36 versions, BWa# controls DQa's and DQPa; BWb# controls DQb's and DQPb; BWc# controls DQc's and DQPC; BWD# controls DQd's and DQPd. Parity is only available on the x18 and x36 versions.
4M	4M	CKE#	Input	Synchronous Clock Enable: This active LOW input permits CLK to propagate throughout the device. When CKE# is HIGH, the device ignores the CK input and effectively internally extends the previous CLK cycle. This input must meet the setup and hold times around the rising edge of CLK.
4H	4H	R/W#	Input	Read/Write: This input determines the cycle type when ADV/LD# is LOW and is the only means for determining READs and WRITEs. READ cycles may not be converted into WRITEs (and vice versa) other than by loading a new address. A LOW on this pin permits BYTE WRITE operations must meet the setup and hold times around the rising edge of CLK. Full bus-width WRITEs occur if all byte write enables are LOW.
4K	4K	CLK	Input	Clock: This signal registers the address, data, chip enable, byte write enables and burst control inputs on its rising edge. All synchronous inputs must meet setup and hold times around the clock's rising edge.
4E	4E	CE#	Input	Synchronous Chip Enable: This active LOW input is used to enable the device. CE# is sampled only when a new external address is loaded.
6B	6B	CE2#	Input	Synchronous Chip Enable: This active LOW input is used to enable the device and is sampled only when a new external address is loaded.
7T	7T	ZZ	Input	Snooze Enable: This active HIGH, asynchronous input causes the device to enter a low-power standby mode in which all data in the memory array is retained. When ZZ is active, all other inputs are ignored.
2B	2B	CE2	Input	Synchronous Chip Enable: This active HIGH input is used to enable the device and is sampled only when a new external address is loaded.

(continued on next page)

BGA PIN DESCRIPTIONS (continued)

x18	x32/x36	SYMBOL	TYPE	DESCRIPTION
4F	4F	OE#	Input	Output Enable: This active LOW, asynchronous input enables the data I/O output drivers.
4B	4B	ADV#/LD#	Input	Synchronous Address Advance/Load: When HIGH, this input is used to advance the internal burst counter, controlling burst access after the external address is loaded. When ADV#/LD# is HIGH, R/W# is ignored. A LOW on ADV#/LD# clocks a new address at the CLK rising edge.
3R	3R	MODE	Input	Mode: This input selects the burst sequence. A LOW on this input selects "linear burst." NC or HIGH on this input selects "interleaved burst." Do not alter input state while device is operating.
4A	4A	NF	Input	No Function: These pins are internally connected to the die and will have the capacitance of input pins. It is allowable to leave these pins unconnected or driven by signals. These pins are reserved for address expansion; 4A becomes an SA at 16Mb density.
(a) 6F, 6H, 6L, 6N, 7E, 7G, 7K, 7P (b) 1D, 1H, 1L, 1N, 2E, 2G, 2K, 2M	(a) 6K, 6L, 6M, 6N, 7K, 7L, 7N, 7P (b) 6E, 6F, 6G, 6H, 7D, 7E, 7G, 7H (c) 1D, 1E, 1G, 1H, 2E, 2F, 2G, 2H (d) 1K, 1L, 1N, 1P, 2K, 2L, 2M, 2N	DQa DQb DQc DQd	Input/ Output	SRAM Data I/Os: For the x18 version, Byte "a" is DQa's; Byte "b" is DQb's. For the x32 and x36 versions, Byte "a" is DQa's; Byte "b" is DQb's; Byte "c" is DQc's; Byte "d" is DQd's. Input data must meet setup and hold times around the rising edge of CLK.
6D 2P – –	6P 6D 2D 2P	NF/DQPa NF/DQPb NF/DQPc NF/DQPd	NF/ I/O	No Function/Parity Data I/Os: On the x32 version, these are No Function (NF). On the x18 version, Byte "a" parity is DQPa; Byte "b" parity is DQPb. On the x36 version, Byte "a" parity is DQPa; Byte "b" parity is DQPb; Byte "c" parity is DQPc; Byte "d" parity is DQPd.
2J, 4C, 4J, 4R, 5R, 6J	2J, 4C, 4J, 4R, 5R, 6J	V _{DD}	Supply	Power Supply: See DC Electrical Characteristics and Operating Conditions for range.
1A, 1F, 1J, 1M, 1U, 7A, 7F, 7J, 7M, 7U	1A, 1F, 1J, 1M, 1U, 7A, 7F, 7J, 7M, 7U	V _{DDQ}	Supply	Isolated Output Buffer Supply: See DC Electrical Characteristics and Operating Conditions for range.

(continued on next page)

BGA PIN DESCRIPTIONS (continued)

x18	x32/x36	SYMBOL	TYPE	DESCRIPTION
3D, 3E, 3F, 3H, 3K, 3L, 3M, 3N, 3P, 5D, 5E, 5F, 5G, 5H, 5K, 5M, 5N, 5P	3D, 3E, 3F, 3H, 3K, 3M, 3N, 3P, 5D, 5E, 5F, 5H, 5K, 5M, 5N, 5P	V _{SS}	Supply	Ground: GND.
2U, 3U, 4U, 5U	2U, 3U, 4U, 5U	DNU	—	Do Not Use: These signals may either be unconnected or wired to GND to improve package heat dissipation.
1B, 1C, 1E, 1G, 1K, 1P, 1R, 1T, 2D, 2F, 2H, 2L, 2N, 3J, 4D, 4L, 4T, 5J, 6E, 6G, 6K, 6M, 6P, 6U, 7B, 7C, 7D, 7H, 7L, 7N, 7R	1B, 1C, 1R, 1T, 2T, 3J, 4D, 4L, 5J, 6T, 6U, 7B, 7C, 7R	NC	—	No Connect: These signals are not internally connected and may be connected to ground to improve package heat dissipation.
		NF	—	No Function: These pins are internally connected to the die and have the capacitance of an input pin. It is allowable to leave these pins unconnected or driven by signals.

INTERLEAVED BURST ADDRESS TABLE (MODE = NC OR HIGH)

FIRST ADDRESS (EXTERNAL)	SECOND ADDRESS (INTERNAL)	THIRD ADDRESS (INTERNAL)	FOURTH ADDRESS (INTERNAL)
X...X00	X...X01	X...X10	X...X11
X...X01	X...X00	X...X11	X...X10
X...X10	X...X11	X...X00	X...X01
X...X11	X...X10	X...X01	X...X00

LINEAR BURST ADDRESS TABLE (MODE = LOW)

FIRST ADDRESS (EXTERNAL)	SECOND ADDRESS (INTERNAL)	THIRD ADDRESS (INTERNAL)	FOURTH ADDRESS (INTERNAL)
X...X00	X...X01	X...X10	X...X11
X...X01	X...X10	X...X11	X...X00
X...X10	X...X11	X...X00	X...X01
X...X11	X...X00	X...X01	X...X10

PARTIAL TRUTH TABLE FOR READ/WRITE COMMANDS (x18)

FUNCTION	R/W#	BW _a #	BW _b #
READ	H	X	X
WRITE Byte "a"	L	L	H
WRITE Byte "b"	L	H	L
WRITE All Bytes	L	L	L
WRITE ABORT/NOP	L	H	H

NOTE: Using R/W# and byte write(s), any one or more bytes may be written.

PARTIAL TRUTH TABLE FOR READ/WRITE COMMANDS (x32/x36)

FUNCTION	R/W#	BW _a #	BW _b #	BW _c #	BW _d #
READ	H	X	X	X	X
WRITE Byte "a"	L	L	H	H	H
WRITE Byte "b"	L	H	L	H	H
WRITE Byte "c"	L	H	H	L	H
WRITE Byte "d"	L	H	H	H	L
WRITE All Bytes	L	L	L	L	L
WRITE ABORT/NOP	L	H	H	H	H

NOTE: Using R/W# and byte write(s), any one or more bytes may be written.

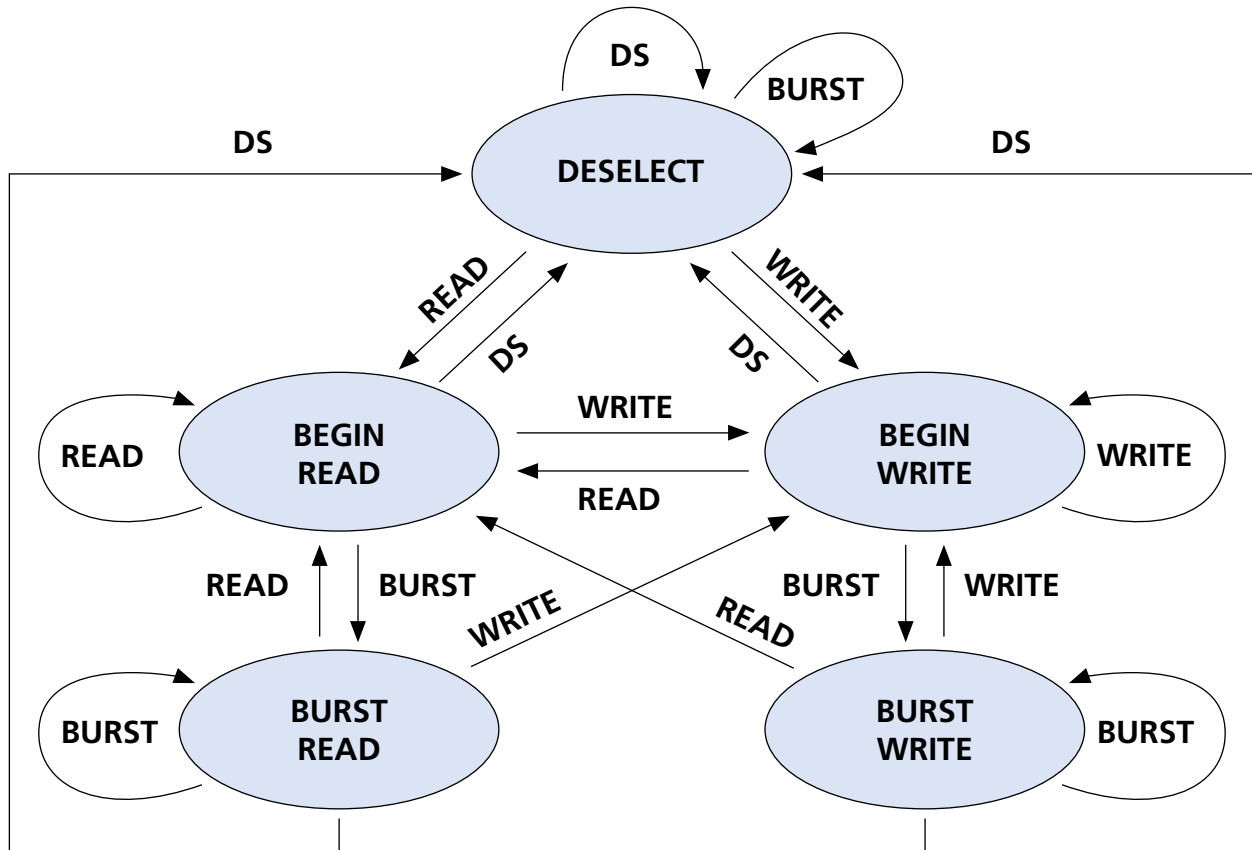
STATE DIAGRAM FOR ZBT SRAM

KEY:

COMMAND	OPERATION
DS	DESELECT
READ	New READ
WRITE	New WRITE
BURST	BURST READ, BURST WRITE or CONTINUE DESELECT

NOTE: 1. A STALL or IGNORE CLOCK EDGE cycle is not shown in the above diagram. This is because CKE# HIGH only blocks the clock (CLK) input and does not change the state of the device.
2. States change on the rising edge of the clock (CLK).

TRUTH TABLE

(Notes 5-10)

OPERATION	ADDRESS USED	CE#	CE2#	CE2	ZZ	ADV/LD#	R/W#	BWx	OE#	CKE#	CLK	DQ	NOTES
DESELECT Cycle	None	H	X	X	L	L	X	X	X	L	L-H	High-Z	
DESELECT Cycle	None	X	H	X	L	L	X	X	X	L	L-H	High-Z	
DESELECT Cycle	None	X	X	L	L	L	X	X	X	L	L-H	High-Z	
CONTINUE DESELECT Cycle	None	X	X	X	L	H	X	X	X	L	L-H	High-Z	1
READ Cycle (Begin Burst)	External	L	L	H	L	L	H	X	L	L	L-H	Q	
READ Cycle (Continue Burst)	Next	X	X	X	L	H	X	X	L	L	L-H	Q	1, 11
NOP/DUMMY READ (Begin Burst)	External	L	L	H	L	L	H	X	H	L	L-H	High-Z	2
DUMMY READ (Continue Burst)	Next	X	X	X	L	H	X	X	H	L	L-H	High-Z	1, 2, 11
WRITE Cycle (Begin Burst)	External	L	L	H	L	L	L	L	X	L	L-H	D	3
WRITE Cycle (Continue Burst)	Next	X	X	X	L	H	X	L	X	L	L-H	D	1, 3, 11
NOP/WRITE ABORT (Begin Burst)	None	L	L	H	L	L	L	H	X	L	L-H	High-Z	2, 3
WRITE ABORT (Continue Burst)	Next	X	X	X	L	H	X	H	X	L	L-H	High-Z	1, 2, 3, 11
IGNORE CLOCK EDGE (Stall)	Current	X	X	X	L	X	X	X	X	H	L-H	–	4
SNOOZE MODE	None	X	X	X	H	X	X	X	X	X	X	High-Z	

- NOTE:**
1. CONTINUE BURST cycles, whether READ or WRITE, use the same control inputs. The type of cycle performed (READ or WRITE) is chosen in the initial BEGIN BURST cycle. A CONTINUE DESELECT cycle can only be entered if a DESELECT cycle is executed first.
 2. DUMMY READ and WRITE ABORT cycles can be considered NOPs because the device performs no external operation. A WRITE ABORT means a WRITE command is given, but no operation is performed.
 3. OE# may be wired LOW to minimize the number of control signals to the SRAM. The device will automatically turn off the output drivers during a WRITE cycle. OE# may be used when the bus turn-on and turn-off times do not meet an application's requirements.
 4. If an IGNORE CLOCK EDGE command occurs during a READ operation, the DQ bus will remain active (Low-Z). If it occurs during a WRITE cycle, the bus will remain in High-Z. No WRITE operations will be performed during the IGNORE CLOCK EDGE cycle.
 5. X means "Don't Care." H means logic HIGH. L means logic LOW. BWx = H means all byte write signals (BWa#, BWb#, BWc# and BWd#) are HIGH. BWx = L means one or more byte write signals are LOW.
 6. BWa# enables WRITES to Byte "a" (DQa pins); BWb# enables WRITES to Byte "b" (DQb pins); BWc# enables WRITES to Byte "c" (DQc pins); BWd# enables WRITES to Byte "d" (DQd pins).
 7. All inputs except OE# and ZZ must meet setup and hold times around the rising edge (LOW to HIGH) of CLK.
 8. Wait states are inserted by setting CKE# HIGH.
 9. This device contains circuitry that will ensure that the outputs will be in High-Z during power-up.
 10. The device incorporates a 2-bit burst counter. Address wraps to the initial address every fourth burst cycle.
 11. The address counter is incremented for all CONTINUE BURST cycles.

ABSOLUTE MAXIMUM RATINGS*

Voltage on V _{DD} Supply	
Relative to V _{SS}	-0.5V to +4.6V
Voltage on V _{DDQ} Supply	
Relative to V _{SS}	-0.5V to V _{DD}
V _{IN} -0.5V to V _{DDQ} + 0.5V	
Storage Temperature (plastic)	-55°C to +150°C
Storage Temperature (FBGA)	-55°C to +125°C
Junction Temperature**	+150°C
Short Circuit Output Current	100mA

*Stresses greater than those listed under “Absolute Maximum Ratings” may cause permanent damage to the device. This is a stress rating only, and functional operation of the device at these or any other conditions above those indicated in the operational sections of this specification is not implied. Exposure to absolute maximum rating conditions for extended periods may affect reliability.

**Junction temperature depends upon package type, cycle time, loading, ambient temperature, and airflow. See Micron Technical Note TN-05-14 for more information.

3.3V I/O DC ELECTRICAL CHARACTERISTICS AND OPERATING CONDITIONS

(0°C ≤ T_A ≤ +70°C; V_{DD}, V_{DDQ} = +3.3V ±0.165V unless otherwise noted)

DESCRIPTION	CONDITIONS	SYMBOL	MIN	MAX	UNITS	NOTES
Input High (Logic 1) Voltage		V _{IH}	2.0	V _{DD} + 0.3	V	1, 2
Input High (Logic 1) Voltage	DQ pins	V _{IH}	2.0	V _{DD} + 0.3	V	1, 2
Input Low (Logic 0) Voltage		V _{IL}	-0.3	0.8	V	1, 2
Input Leakage Current	0V ≤ V _{IN} ≤ V _{DD}	I _{LI}	-1.0	1.0	μA	3
Output Leakage Current	Output(s) disabled, 0V ≤ V _{IN} ≤ V _{DD}	I _{LO}	-1.0	1.0	μA	
Output High Voltage	I _{OH} = -4.0mA	V _{OH}	2.4	–	V	1, 4
Output Low Voltage	I _{OL} = 8.0mA	V _{OL}	–	0.4	V	1, 4
Supply Voltage		V _{DD}	3.135	3.465	V	1
Isolated Output Buffer Supply		V _{DDQ}	3.135	V _{DD}	V	1, 5

- NOTE:**
- All voltages referenced to V_{SS} (GND).
 - Overshoot: V_{IH} ≤ +4.6V for t ≤ ^tKHKH/2 for I ≤ 20mA
Undershoot: V_{IL} ≥ -0.7V for t ≤ ^tKHKH/2 for I ≤ 20mA
Power-up: V_{IH} ≤ +3.465V and V_{DD} ≤ +3.135V for t ≤ 200ms
 - MODE pin has an internal pull-up, and input leakage = ±10μA.
 - The load used for V_{OH}, V_{OL} testing is shown in Figure 2. AC load current is higher than the shown DC values. AC I/O curves are available upon request.
 - V_{DDQ} should never exceed V_{DD}. V_{DD} and V_{DDQ} can be externally wired together to the same power supply.

2.5V I/O DC ELECTRICAL CHARACTERISTICS AND OPERATING CONDITIONS

(0°C ≤ T_A ≤ +70°C; V_{DD} = +3.3V ±0.165V; V_{DDQ} = +2.5V +0.4V/-0.125V unless otherwise noted)

DESCRIPTION	CONDITIONS	SYMBOL	MIN	MAX	UNITS	NOTES
Input High (Logic 1) Voltage	Data bus (DQx)	V _{IHQ}	1.7	V _{DDQ} + 0.3	V	1, 2
	Inputs	V _{IH}	1.7	V _{DD} + 0.3	V	1, 2
Input Low (Logic 0) Voltage		V _{IL}	-0.3	0.7	V	1, 2
Input Leakage Current	0V ≤ V _{IN} ≤ V _{DD}	I _{LI}	-1.0	1.0	μA	3
Output Leakage Current	Output(s) disabled, 0V ≤ V _{IN} ≤ V _{DDQ} (DQx)	I _{LO}	-1.0	1.0	μA	
Output High Voltage	I _{OH} = -2.0mA	V _{OH}	1.7	–	V	1
	I _{OH} = -1.0mA	V _{OH}	2.0	–	V	1
Output Low Voltage	I _{OL} = 2.0mA	V _{OL}	–	0.7	V	1
	I _{OL} = 1.0mA	V _{OL}	–	0.4	V	1
Supply Voltage		V _{DD}	3.135	3.465	V	1
Isolated Output Buffer Supply		V _{DDQ}	2.375	2.9	V	1

TQFP CAPACITANCE

DESCRIPTION	CONDITIONS	SYMBOL	TYP	MAX	UNITS	NOTES
Control Input Capacitance	T _A = +25°C; f = 1 MHz V _{DD} = +3.3V	C _I	3	4	pF	4
Input/Output Capacitance (DQ)		C _O	4	5	pF	4
Address Capacitance		C _A	3	3.5	pF	4
Clock Capacitance		C _{CK}	3	3.5	pF	4

BGA CAPACITANCE

DESCRIPTION	CONDITIONS	SYMBOL	TYP	MAX	UNITS	NOTES
Address/Control Input Capacitance	T _A = +25°C; f = 1 MHz V _{DD} = 3.3V	C _I	4	7	pF	4
Input/Output Capacitance (DQ)		C _O	4.5	5.5	pF	4
Address Capacitance		C _A	4	7	pF	4
Clock Capacitance		C _{CK}	4.5	5.5	pF	4

FBGA CAPACITANCE

DESCRIPTION	CONDITIONS	SYMBOL	TYP	MAX	UNITS	NOTES
Address/Control Input Capacitance	T _A = 25°C; f = 1 MHz	C _I	2.5	3.5	pF	4, 5
Output Capacitance (Q)		C _O	4	5	pF	4, 5
Clock Capacitance		C _{CK}	2.5	3.5	pF	4, 5

- NOTE:**
- All voltages referenced to V_{SS} (GND).
 - Overshoot: V_{IH} ≤ +4.6V for t ≤ ^tKHKH/2 for I ≤ 20mA
Undershoot: V_{IL} ≥ -0.7V for t ≤ ^tKHKH/2 for I ≤ 20mA
Power-up: V_{IH} ≤ +3.465V and V_{DD} ≤ +3.135V for t ≤ 200ms
 - MODE pin has an internal pull-up, and input leakage = ±10μA.
 - This parameter is sampled.
 - Preliminary package data.

I_{DD} OPERATING CONDITIONS AND MAXIMUM LIMITS

 (Note 1) (0°C ≤ T_A ≤ +70°C; V_{DD} = +3.3V ±0.165V unless otherwise noted)

DESCRIPTION	CONDITIONS	SYMBOL	TYP	MAX			UNITS	NOTES
				-6	-7.5	-10		
Power Supply Current: Operating	Device selected; All inputs ≤ V _{IL} or ≥ V _{IH} ; Cycle time ≥ ^t KC (MIN); V _{DD} = MAX; Outputs open	I _{DD}	200	500	400	300	mA	2, 3, 4
Power Supply Current: Idle	Device selected; V _{DD} = MAX; CKE# ≥ V _{IH} ; All inputs ≤ V _{SS} + 0.2 or ≥ V _{DD} - 0.2; Cycle time ≥ ^t KC (MIN)	I _{DD1}	10	25	25	20	mA	2, 3, 4
CMOS Standby	Device deselected; V _{DD} = MAX; All inputs ≤ V _{SS} + 0.2 or ≥ V _{DD} - 0.2; All inputs static; CLK frequency = 0	I _{SB2}	0.5	10	10	10	mA	3, 4
TTL Standby	Device deselected; V _{DD} = MAX; All inputs ≤ V _{IL} or ≥ V _{IH} ; All inputs static; CLK frequency = 0	I _{SB3}	6	25	25	25	mA	3, 4
Clock Running	Device deselected; V _{DD} = MAX; ADV/LD# ≥ V _{IH} ; All inputs ≤ V _{SS} + 0.2 or ≥ V _{DD} - 0.2; Cycle time ≥ ^t KC (MIN)	I _{SB4}	45	120	75	60	mA	3, 4
Snooze Mode	ZZ ≥ V _{IH}	I _{SB2Z}	0.5	10	10	10	mA	4

TQFP THERMAL RESISTANCE

DESCRIPTION	CONDITIONS	SYMBOL	TYP	UNITS	NOTES
Thermal Resistance (Junction to Ambient)	Test conditions follow standard test methods and procedures for measuring thermal impedance, per EIA/JESD51.	θ _{JA}	40	°C/W	5
Thermal Resistance (Junction to Top of Case)		θ _{JC}	8	°C/W	5

BGA THERMAL RESISTANCE

DESCRIPTION	CONDITIONS	SYMBOL	TYP	UNITS	NOTES
Junction to Ambient (Airflow of 1m/s)	Test conditions follow standard test methods and procedures for measuring thermal impedance, per EIA/JESD51.	θ _{JA}	40	°C/W	5
Junction to Case (Top)		θ _{JC}	9	°C/W	5

- NOTE:**
- V_{DDQ} = +3.3V ±0.165V for 3.3V I/O configuration; V_{DDQ} = +2.5V +0.4V/-0.125V for 2.5V I/O configuration.
 - I_{DD} is specified with no output current and increases with faster cycle times. I_{DDQ} increases with faster cycle times and greater output loading.
 - "Device deselected" means device is in a deselected cycle as defined in the truth table. "Device selected" means device is active (not in deselected mode).
 - Typical values are measured at +3.3V, +25°C and 10ns cycle time.
 - This parameter is sampled.

FBGA THERMAL RESISTANCE

DESCRIPTION	CONDITIONS	SYMBOL	TYP	UNITS	NOTES
Junction to Ambient (Airflow of 1m/s)	Test conditions follow standard test methods and procedures for measuring thermal impedance, per EIA/JESD51.	θ_{JA}	40	°C/W	1, 11
Junction to Case (Top)		θ_{JC}	9	°C/W	1, 11
Junction to Pins (Bottom)		θ_{JB}	17	°C/W	1, 11

AC ELECTRICAL CHARACTERISTICS

 (Notes 2, 3, 4) ($0^{\circ}\text{C} \leq T_A \leq +70^{\circ}\text{C}$; $V_{DD} = +3.3\text{V} \pm 0.165\text{V}$ unless otherwise noted)

DESCRIPTION	SYMBOL	-6		-7.5		-10		UNITS	NOTES
		MIN	MAX	MIN	MAX	MIN	MAX		
Clock									
Clock cycle time	t_{KHKH}	6.0		7.5		10		ns	
Clock frequency	f_{KF}		166		133		100	MHz	
Clock HIGH time	t_{KHKL}	1.7		2.0		3.2		ns	5
Clock LOW time	t_{KLKH}	1.7		2.0		3.2		ns	5
Output Times									
Clock to output valid	t_{KHQV}		3.5		4.2		5.0	ns	
Clock to output invalid	t_{KHQX}	1.5		1.5		1.5		ns	6
Clock to output in Low-Z	t_{KHQX1}	1.5		1.5		1.5		ns	6, 7, 8, 9
Clock to output in High-Z	t_{KHQZ}	1.5	3.5	1.5	3.5	1.5	3.5	ns	6, 7, 8, 9
OE# to output valid	t_{GLQV}		3.5		4.2		5.0	ns	2
OE# to output in Low-Z	t_{GLQX}	0		0		0		ns	6, 7, 8, 9
OE# to output in High-Z	t_{GHQZ}		3.5		4.2		5.0	ns	6, 7, 8, 9
Setup Times									
Address	t_{AVKH}	1.5		1.7		2.0		ns	10
Clock enable (CKE#)	t_{EVKH}	1.5		1.7		2.0		ns	10
Control signals	t_{CVKH}	1.5		1.7		2.0		ns	10
Data-in	t_{DVKH}	1.5		1.7		2.0		ns	10
Hold Times									
Address	t_{KHAX}	0.5		0.5		0.5		ns	10
Clock enable (CKE#)	t_{KHEX}	0.5		0.5		0.5		ns	10
Control signals	t_{KHGX}	0.5		0.5		0.5		ns	10
Data-in	t_{KHDX}	0.5		0.5		0.5		ns	10

- NOTE:**
1. This parameter is sampled.
 2. OE# can be considered a "Don't Care" during WRITES; however, controlling OE# can help fine-tune a system for turnaround timing.
 3. Test conditions as specified with output loading as shown in Figure 1 for 3.3V I/O ($V_{DDQ} = +3.3\text{V} \pm 0.165\text{V}$) and Figure 3 for 2.5V I/O ($V_{DDQ} = +2.5\text{V} +0.4\text{V}/-0.125\text{V}$).
 4. A WRITE cycle is defined by R/W# LOW having been registered into the device at ADV/LD# LOW. A READ cycle is defined by R/W# HIGH with ADV/LD# LOW. Both cases must meet setup and hold times.
 5. Measured as HIGH above V_{IH} and LOW below V_{IL} .
 6. Refer to Technical Note TN-55-01, "Designing with ZBT SRAMs," for a more thorough discussion on these parameters.
 7. This parameter is sampled.
 8. This parameter is measured with output loading as shown in Figure 2 for 3.3V I/O and Figure 4 for 2.5V I/O.
 9. Transition is measured $\pm 200\text{mV}$ from steady state voltage.
 10. This is a synchronous device. All addresses must meet the specified setup and hold times for all rising edges of CLK when they are being registered into the device. All other synchronous inputs must meet the setup and hold times with stable logic levels for all rising edges of clock (CLK) when the chip is enabled. Chip enable must be valid at each rising edge of CLK when ADV/LD# is LOW to remain enabled.
 11. Preliminary package data.

3.3V I/O AC TEST CONDITIONS

Input pulse levels	V _{ss} to 3.3V
Input rise and fall times	1ns
Input timing reference levels	1.5V
Output reference levels	1.5V
Output load	See Figures 1 and 2

2.5V I/O AC TEST CONDITIONS

Input pulse levels	V _{ss} to 2.5V
Input rise and fall times	1ns
Input timing reference levels	1.25V
Output reference levels	1.25V
Output load	See Figures 3 and 4

3.3V I/O Output Load Equivalents

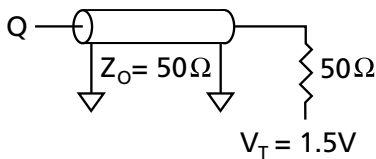

Figure 1

2.5V I/O Output Load Equivalents

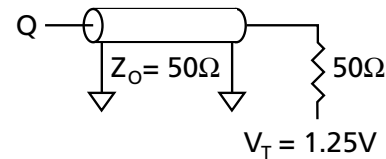

Figure 3

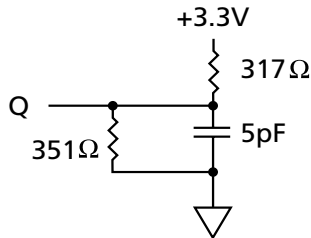

Figure 2

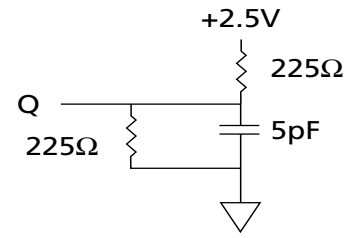

Figure 4

LOAD DERATING CURVES

The Micron 512K x 18, 256K x 32, and 256K x 36 ZBT SRAM timing is dependent upon the capacitive loading on the outputs.

Consult the factory for copies of I/O current versus voltage curves.

SNOOZE MODE

SNOOZE MODE is a low-current, “power-down” mode in which the device is deselected and current is reduced to I_{SB2Z} . The duration of SNOOZE MODE is dictated by the length of time the ZZ pin is in a HIGH state. After the device enters SNOOZE MODE, all inputs except ZZ become disabled and all outputs go to High-Z.

The ZZ pin is an asynchronous, active HIGH input that causes the device to enter SNOOZE MODE. When

the ZZ pin becomes a logic HIGH, I_{SB2Z} is guaranteed after the time t_{ZZI} is met. Any READ or WRITE operation pending when the device enters SNOOZE MODE is not guaranteed to complete successfully. Therefore, SNOOZE MODE must not be initiated until valid pending operations are completed. Similarly, when exiting SNOOZE MODE during t_{RZZ} , only a DESELECT or READ cycle should be given.

SNOOZE MODE ELECTRICAL CHARACTERISTICS

DESCRIPTION	CONDITIONS	SYMBOL	MIN	MAX	UNITS	NOTES
Current during SNOOZE MODE	$ZZ \geq V_{IH}$	I_{SB2Z}		10	m A	
ZZ active to input ignored		t_{ZZ}	0	$2(t_{KHKH})$	ns	1
ZZ inactive to input sampled		t_{RZZ}	0	$2(t_{KHKH})$	ns	1
ZZ active to snooze current		t_{ZZI}		$2(t_{KHKH})$	ns	1
ZZ inactive to exit snooze current		t_{RZZI}	0		ns	1

NOTE: 1. This parameter is sampled.

SNOOZE MODE WAVEFORM

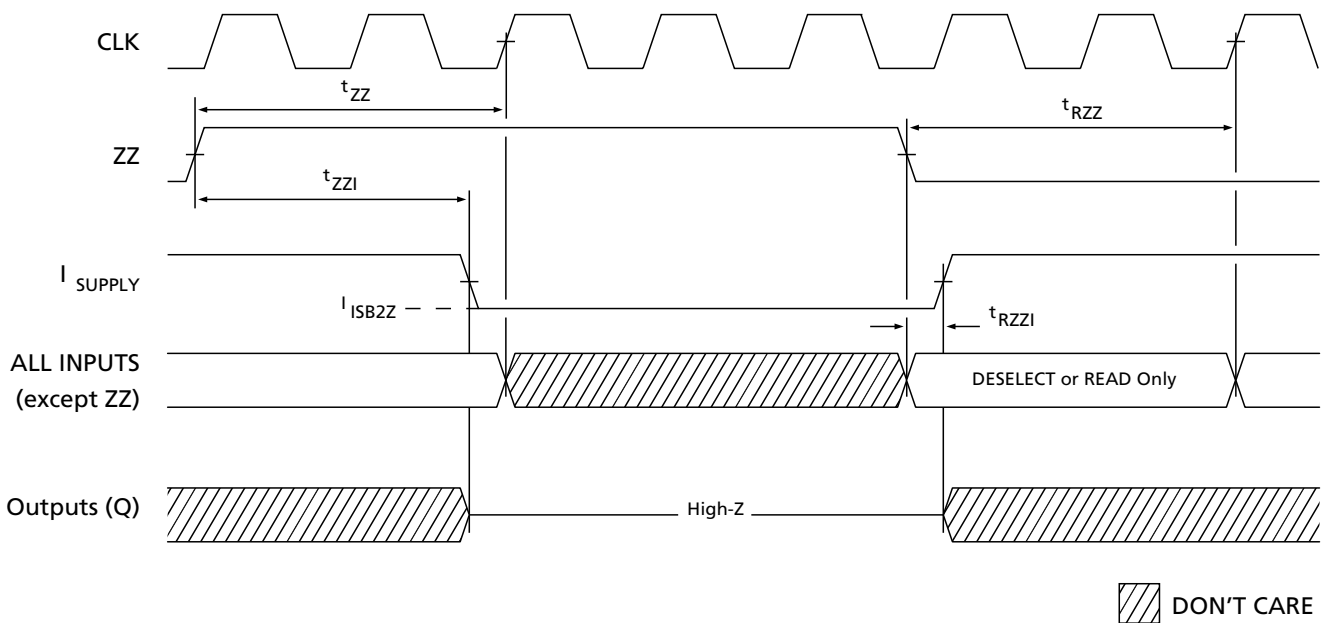

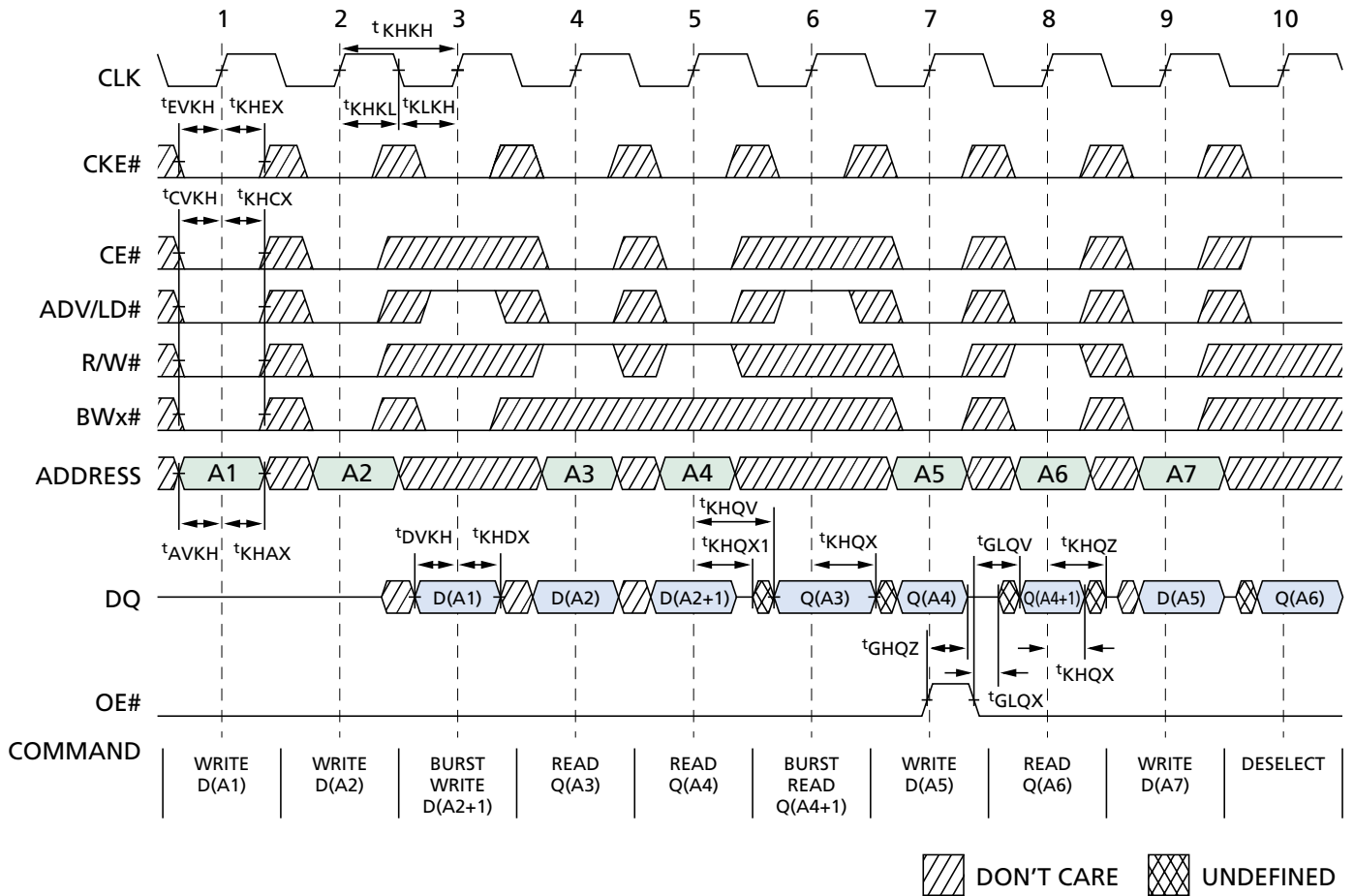
READ/WRITE TIMING

READ/WRITE TIMING PARAMETERS

SYM	-6		-7.5		-10		UNITS
	MIN	MAX	MIN	MAX	MIN	MAX	
t_{KHKK}	6.0		7.5		10		ns
f_{KF}		166		133		100	MHz
t_{KHKL}	1.7		2.0		3.2		ns
t_{KLKH}	1.7		2.0		3.2		ns
t_{KHQV}		3.5		4.2		5.0	ns
t_{KHQX}	1.5		1.5		1.5		ns
t_{KHQX1}	1.5		1.5		1.5		ns
t_{KHQZ}	1.5	3.5	1.5	3.5	1.5	3.5	ns
t_{GLQV}		3.5		4.2		5.0	ns
t_{GLQX}	0		0		0		ns

SYM	-6		-7.5		-10		UNITS
	MIN	MAX	MIN	MAX	MIN	MAX	
t_{GHQZ}		3.5		4.2		5.0	ns
t_{AVKH}	1.5		1.7		2.0		ns
t_{EVKH}	1.5		1.7		2.0		ns
t_{CVKH}	1.5		1.7		2.0		ns
t_{DVKH}	1.5		1.7		2.0		ns
t_{KHAX}	0.5		0.5		0.5		ns
t_{KHEX}	0.5		0.5		0.5		ns
t_{KHCX}	0.5		0.5		0.5		ns
t_{KHDX}	0.5		0.5		0.5		ns

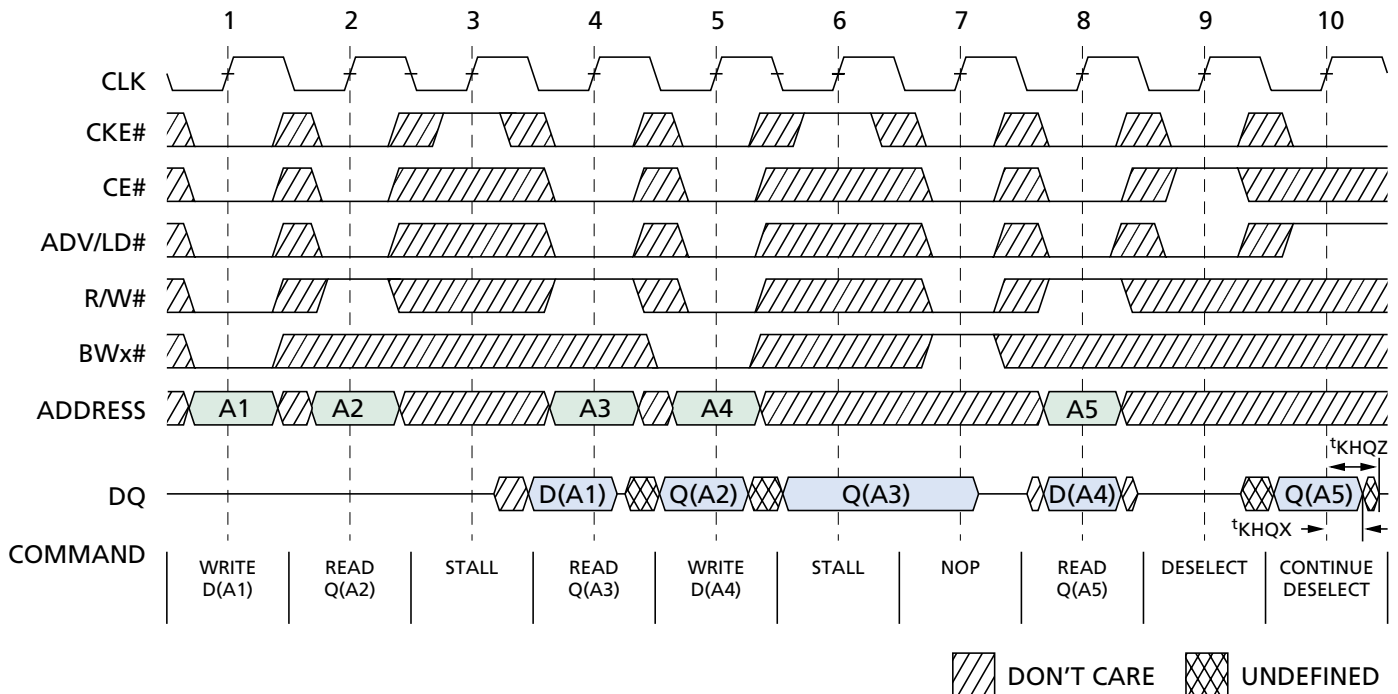
- NOTE:**
- For this waveform, ZZ is tied LOW.
 - Burst sequence order is determined by MODE (0 = linear, 1 = interleaved). BURST operations are optional.
 - CE# represents three signals. When CE# = 0, it represents CE# = 0, CE2# = 0, CE2 = 1.
 - Data coherency is provided for all possible operations. If a READ is initiated, the most current data is used. The most recent data may be from the input data register.

NOP, STALL, AND DESELECT CYCLES

NOP, STALL, AND DESELECT TIMING PARAMETERS

SYM	-6		-7.5		-10		UNITS
	MIN	MAX	MIN	MAX	MIN	MAX	
t_{KHQX}	1.5		1.5		1.5		ns
t_{KHQZ}	1.5	3.5	1.5	3.5	1.5	3.5	ns

- NOTE:**
1. The IGNORE CLOCK EDGE or STALL cycle (clock 3) illustrates CKE# being used to create a “pause.” A WRITE is not performed during this cycle.
 2. For this waveform, ZZ and OE# are tied LOW.
 3. CE# represents three signals. When CE# = 0, it represents CE# = 0, CE2# = 0, CE2 = 1.
 4. Data coherency is provided for all possible operations. If a READ is initiated, the most current data is used. The most recent data may be from the input data register.

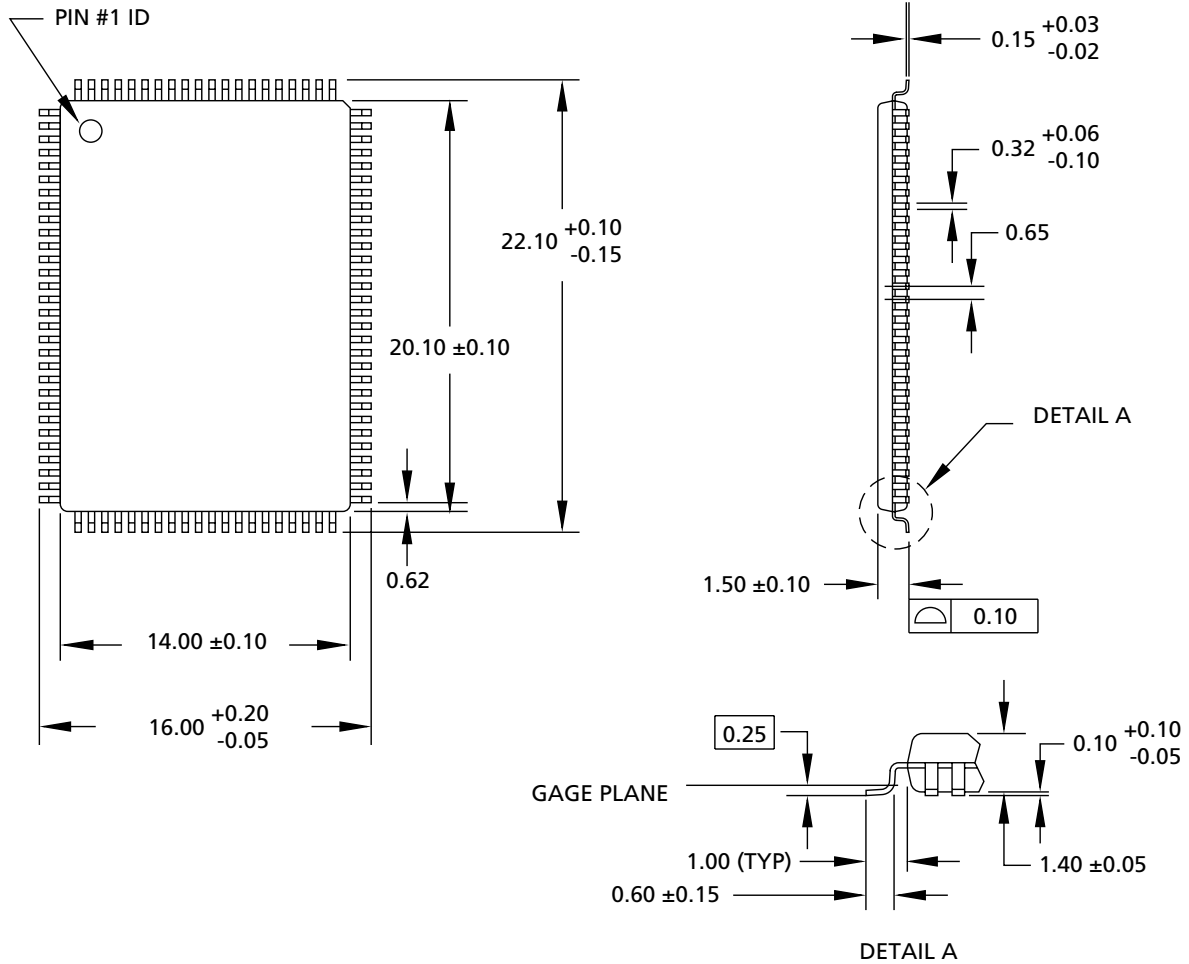
100-PIN PLASTIC TQFP (JEDEC LQFP)



- NOTE:**
1. All dimensions in millimeters.
 2. Package width and length do not include mold protrusion; allowable mold protrusion is 0.25mm per side.

165-PIN FBGA

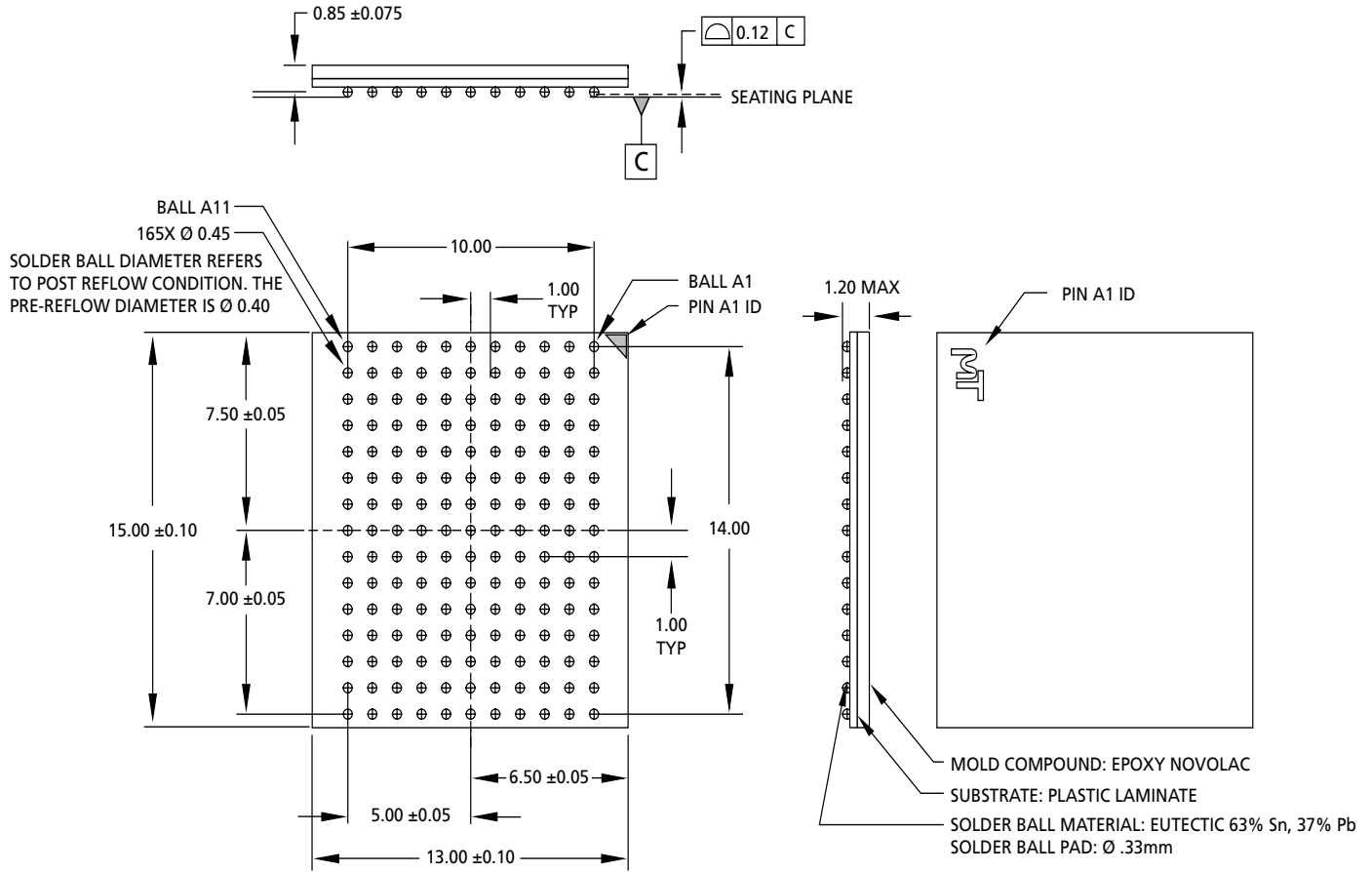

NOTE: 1. All dimensions in millimeters $\frac{MAX}{MIN}$ or typical where noted.

119-PIN BGA

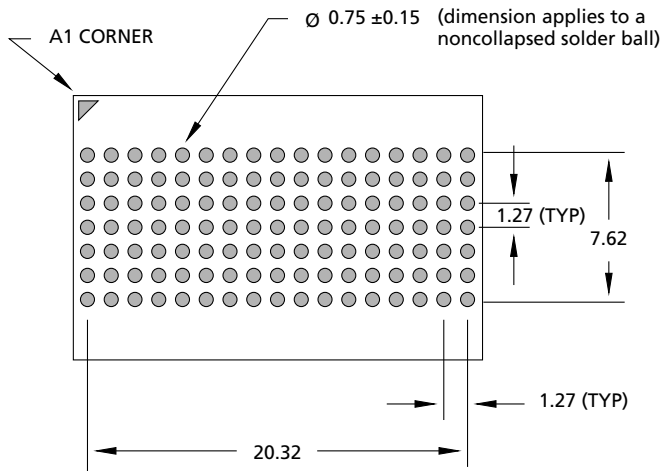
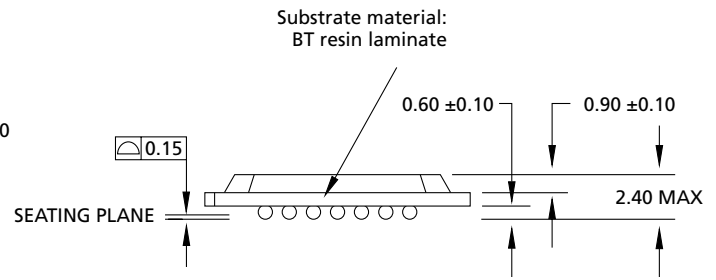
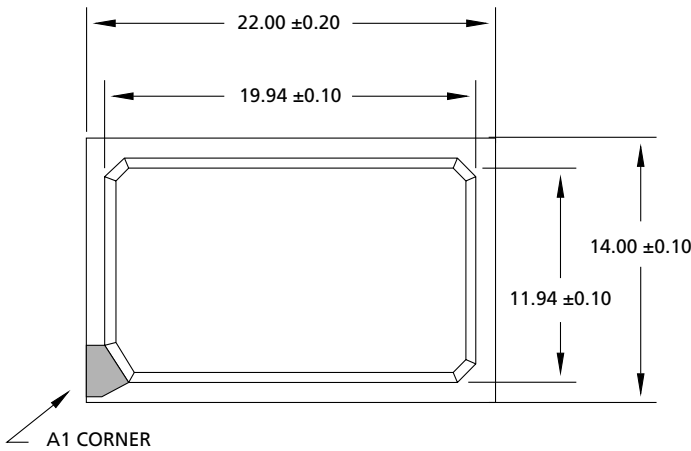

- NOTE:** 1. All dimensions in millimeters $\frac{MAX}{MIN}$ or typical where noted.
2. Solder ball land pad is 0.6mm.



**8000 S. Federal Way, P.O. Box 6, Boise, ID 83707-0006, Tel: 208-368-3900
E-mail: prodmktg@micron.com, Internet: http://www.micronsemi.com, Customer Comment Line: 800-932-4992**

Micron is a registered trademark of Micron Technology, Inc.
ZBT and Zero Bus Turnaround are trademarks of Integrated Device Technology, Inc.,
and the architecture is supported by Micron Technology, Inc., and Motorola Inc.

REVISION HISTORY

Removed note "Not Recommended for New Designs," Rev. 6/01	June 7/01
Added industrial temperature references and notes, Rev. 3/01	March 19/01
Changed 16Mb references to 18Mb	
Changed NC/DQPx to NF/DQPx	
Added 119-pin PBGA package, Rev. 1/01, FINAL	1/10/01
Removed FBGA Part Marking Guide, Rev. 8/00, FINAL	8/1/00
Added FBGA Part Marking Guide, REV 7/00, FINAL	7/20/00
Added Revision History	
Removed 119-Pin PBGA package and references	
Added 165-pin FBGA Package	6/13/00
Removed "Smart ZBT" references	6/13/00